

## Capítulo 37 (Turn) Turno

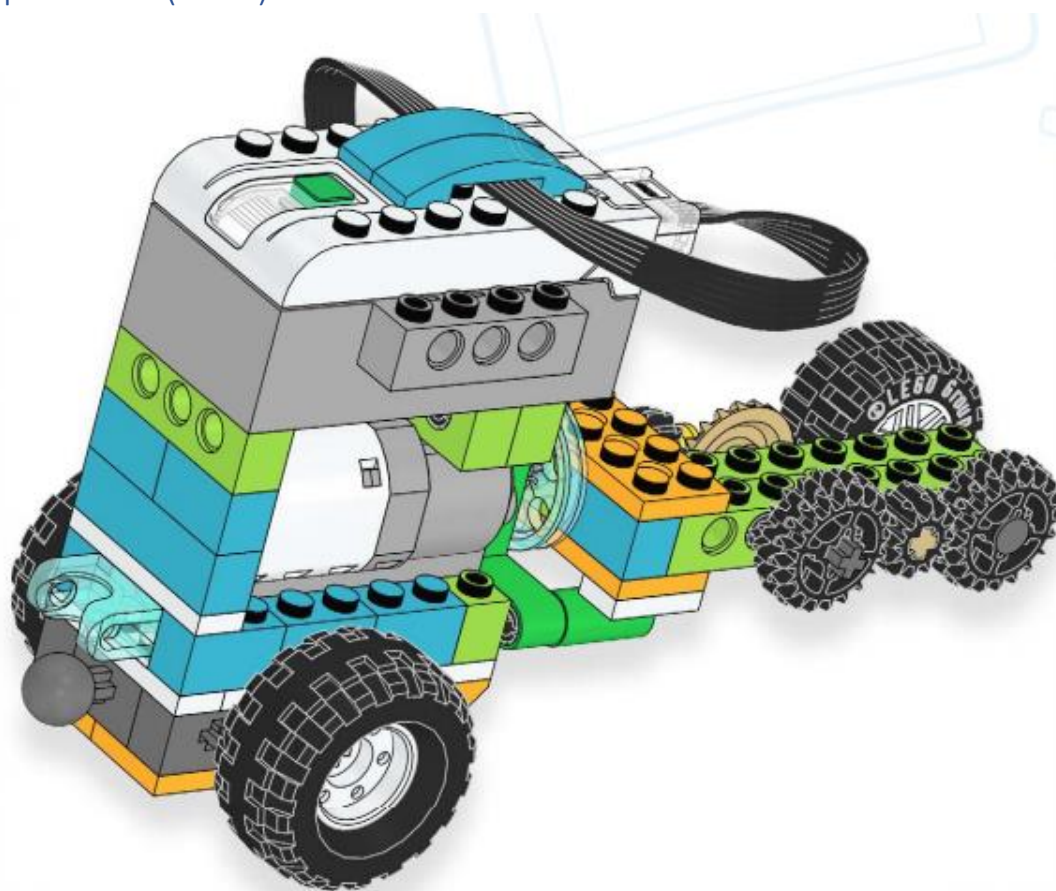

Para realizar este capítulo necesitaremos un solo Kit.

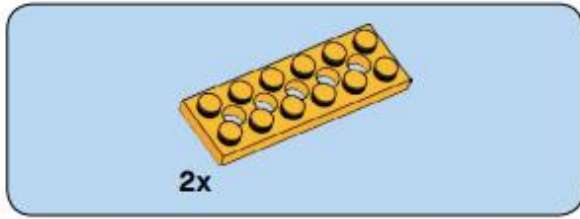

**1**

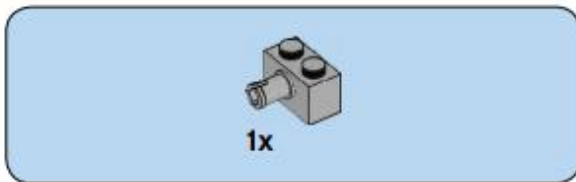
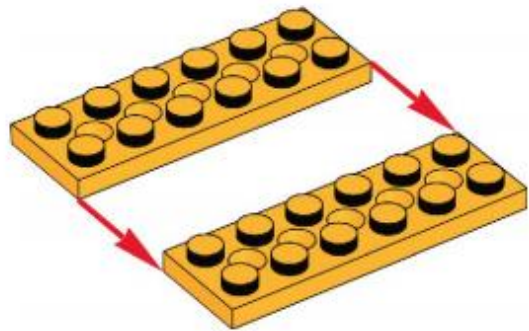

**2**

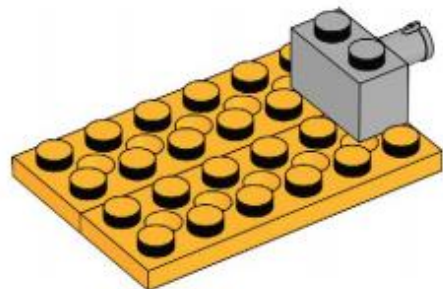

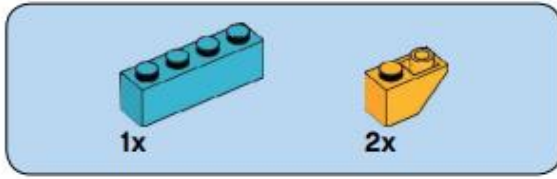

**3**

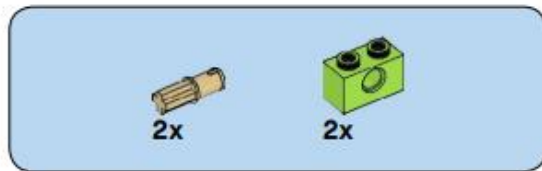
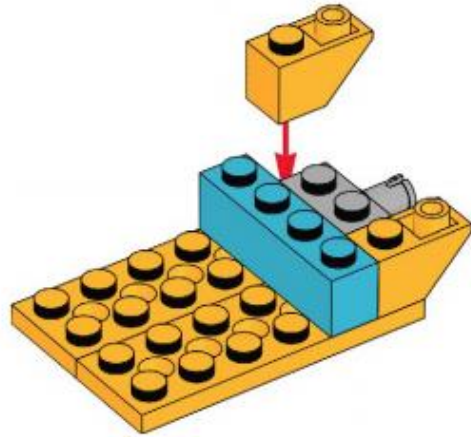

**4**

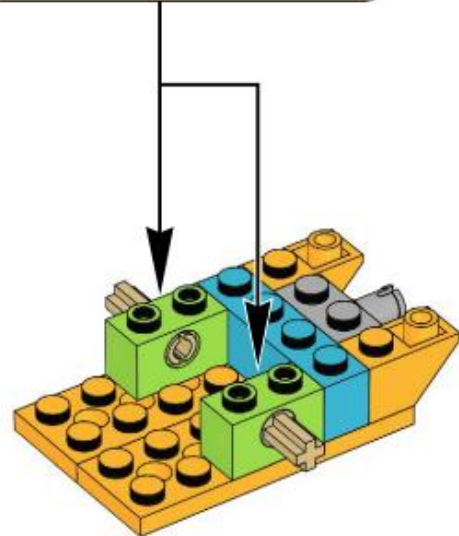
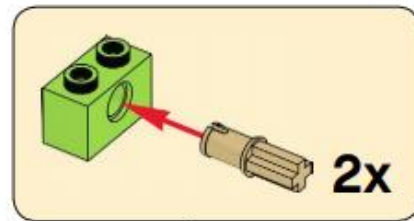

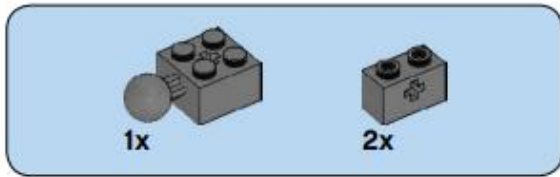

5

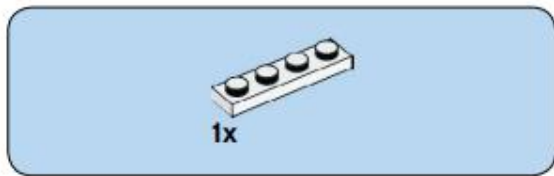
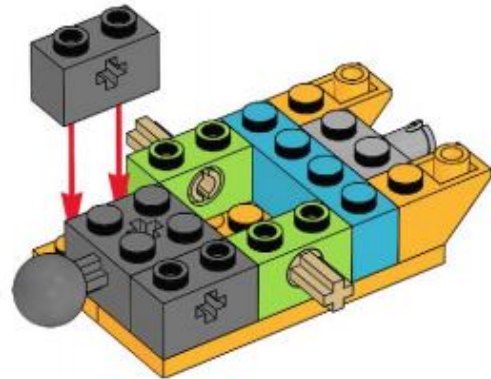

6

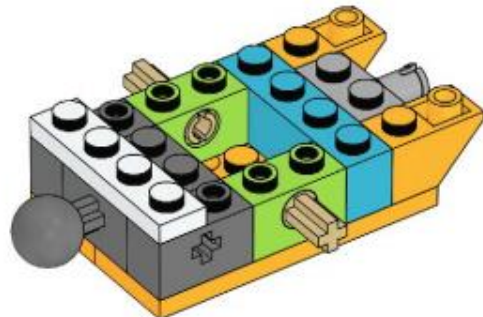

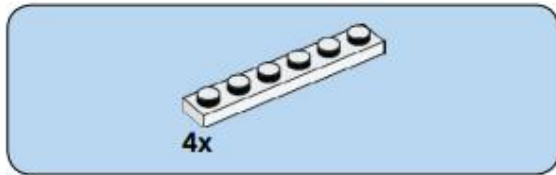

7

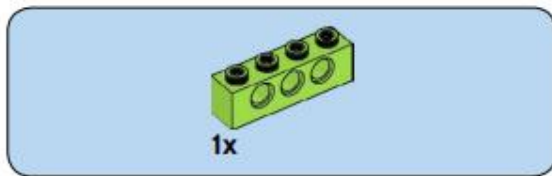
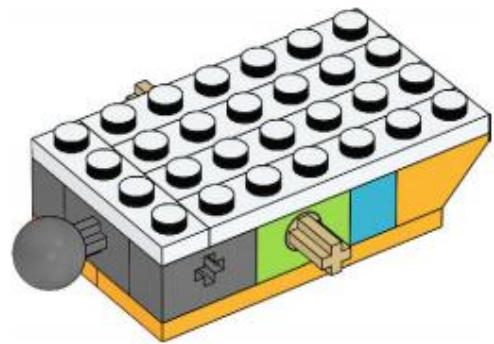

8

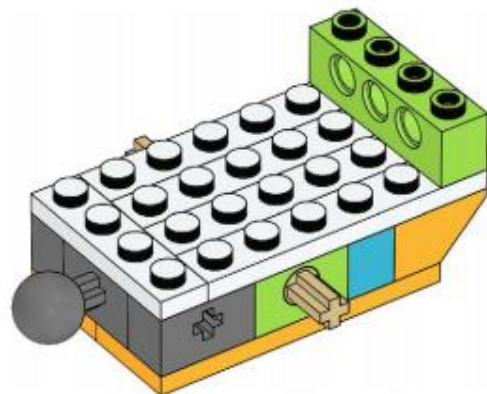

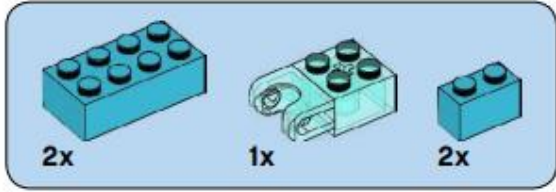

9

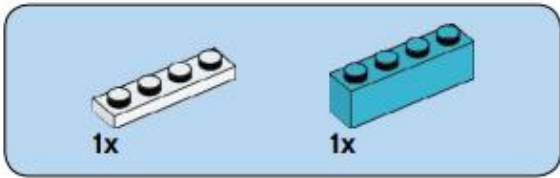
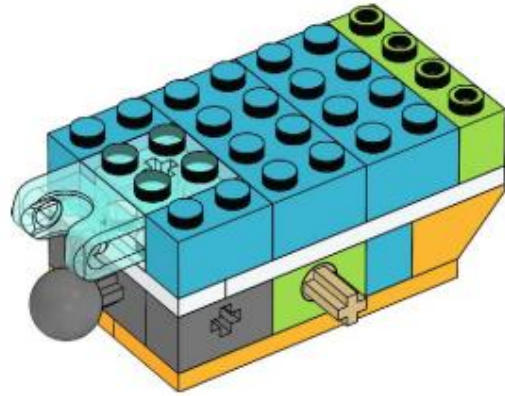

10

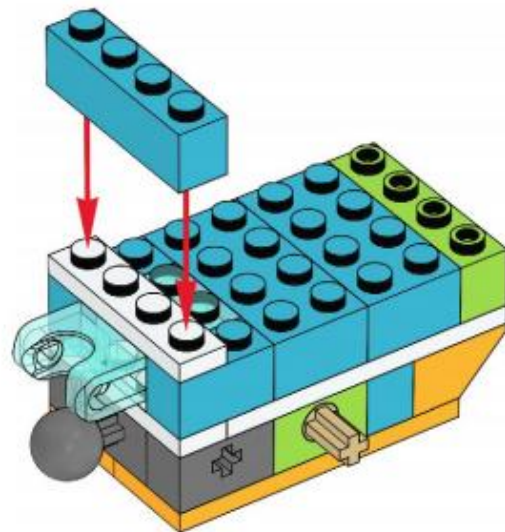

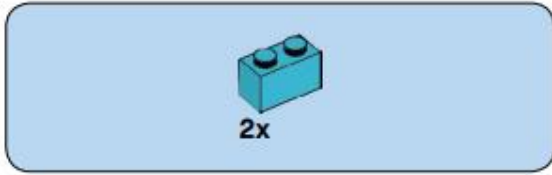

**11**

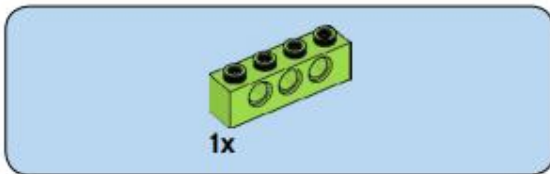
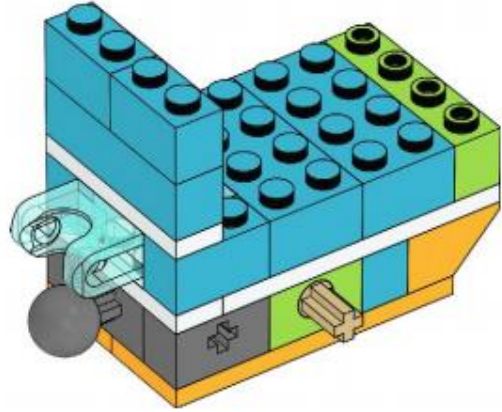

**12**

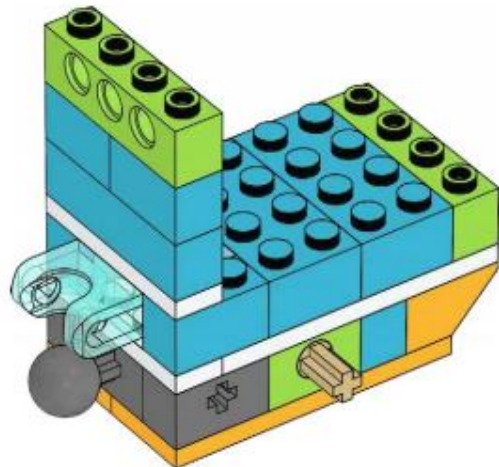

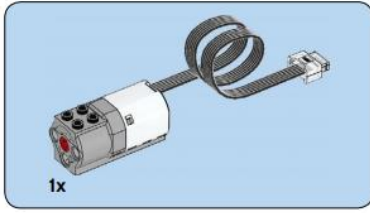

13

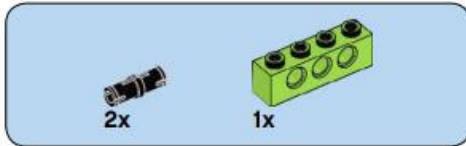
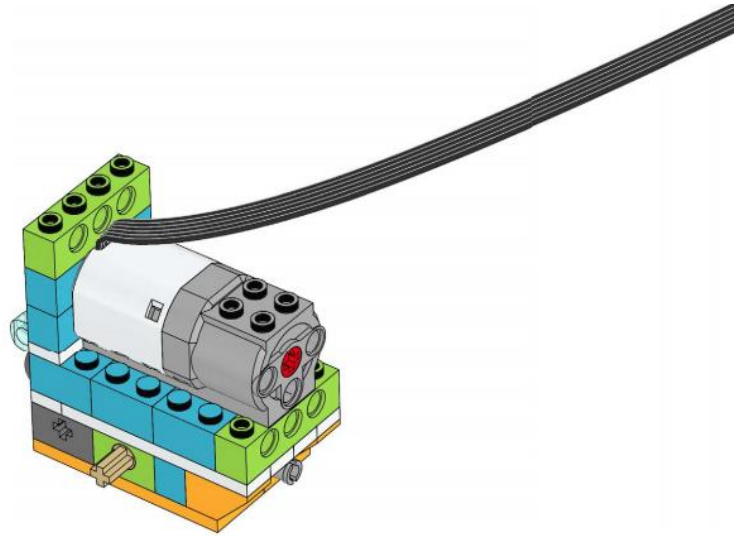

14

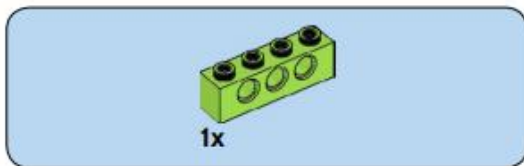

15





16

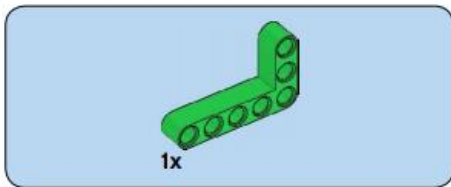
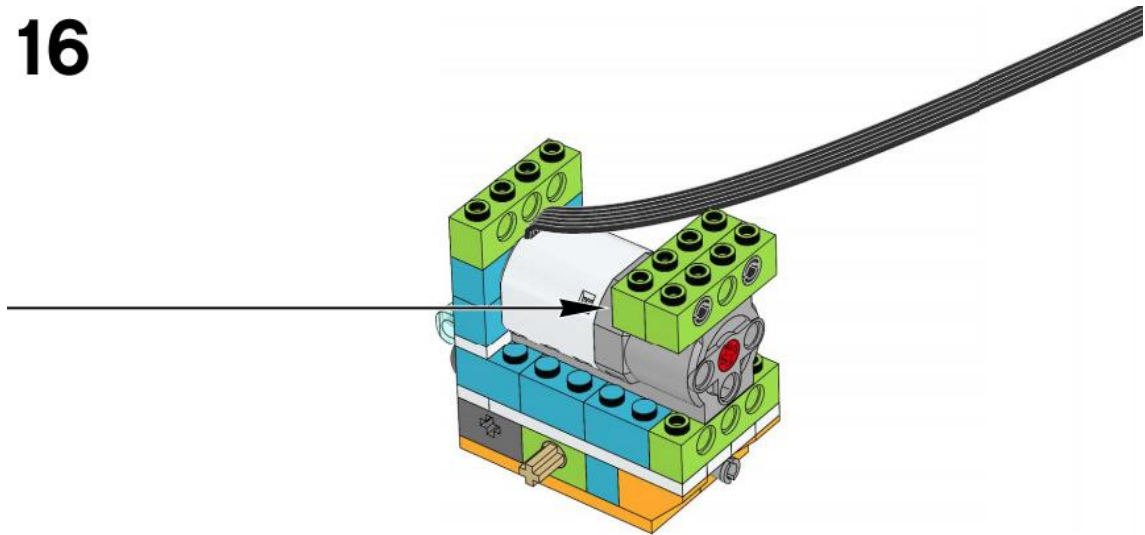

17

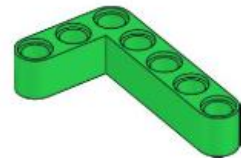

18

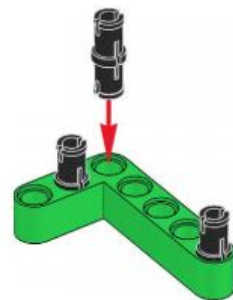

19

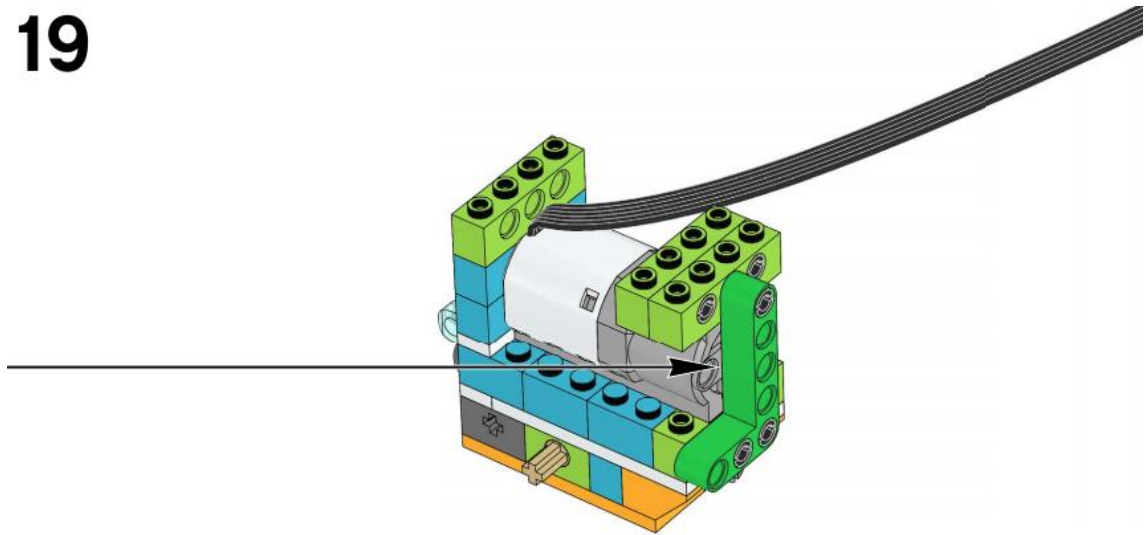

20

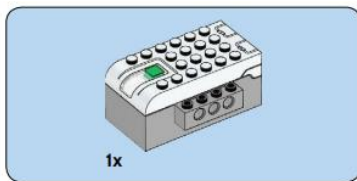
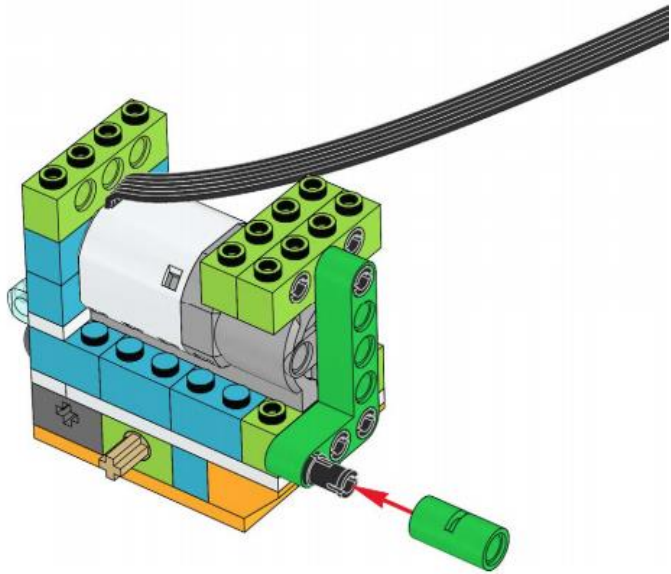

21

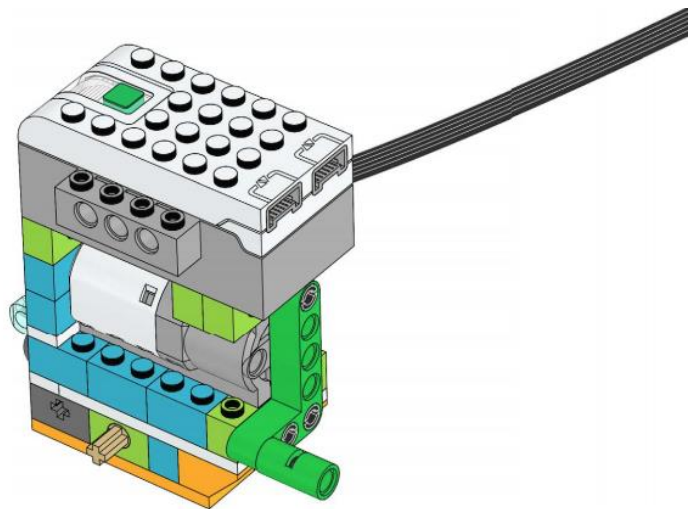

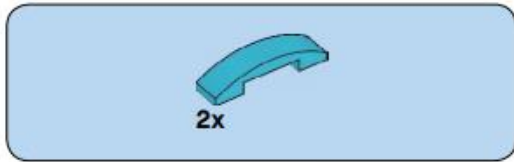

22

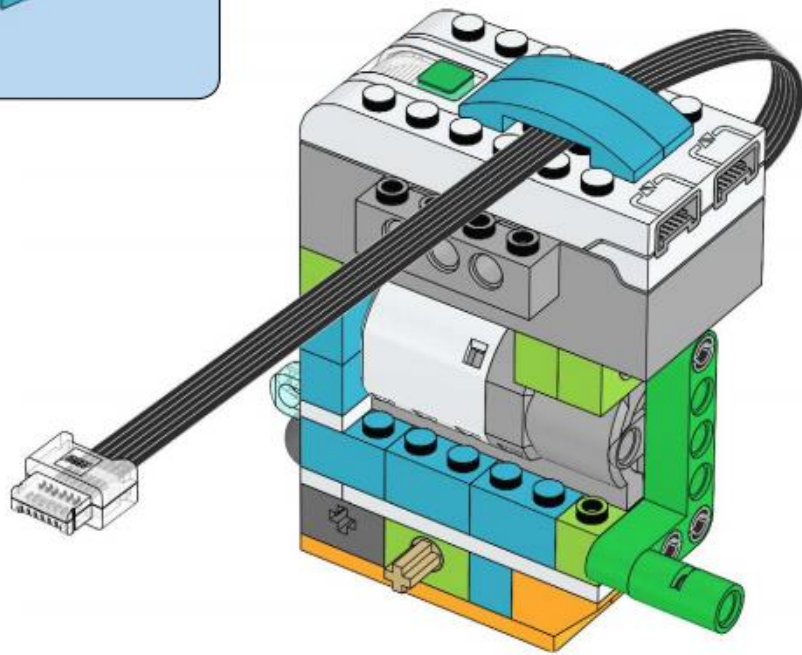

23

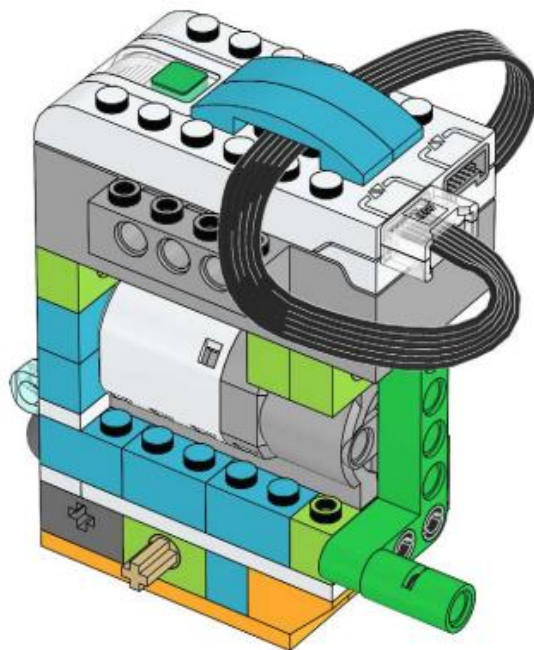

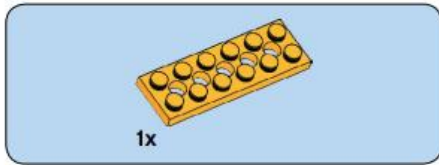

**24**

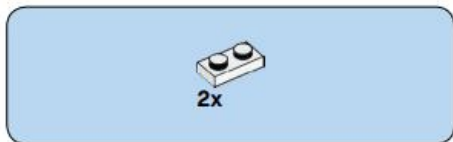
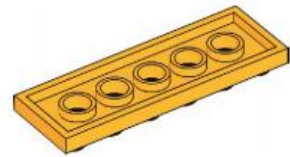

**25**

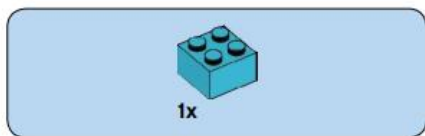
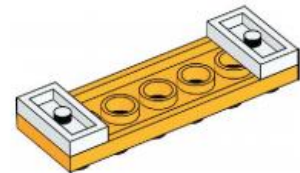

**26**

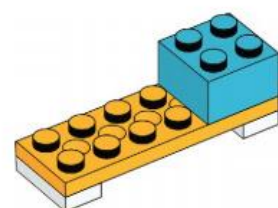

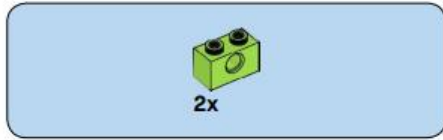

27

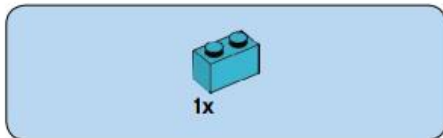
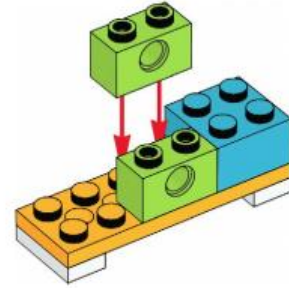

28

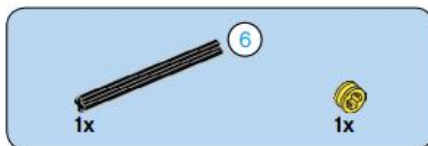
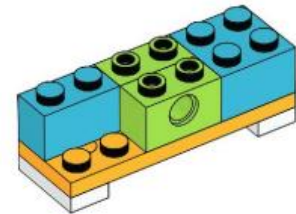

29



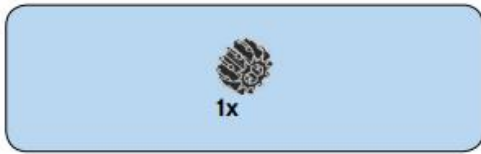

**30**



**31**

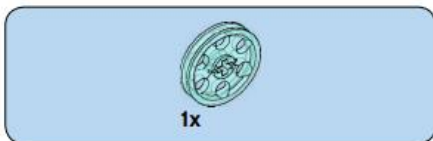
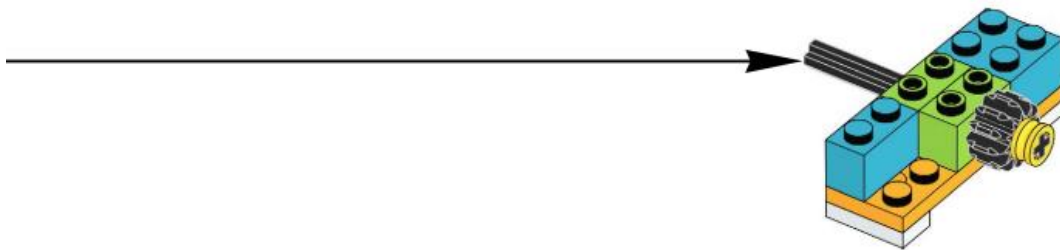

**32**

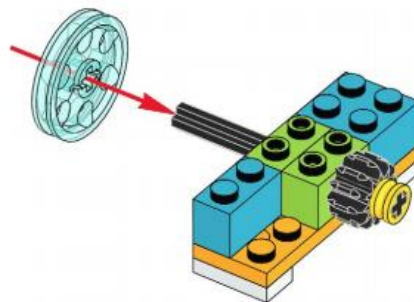

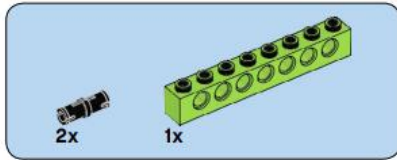

33

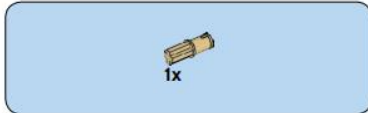
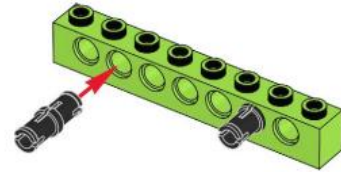

34

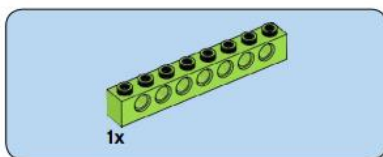
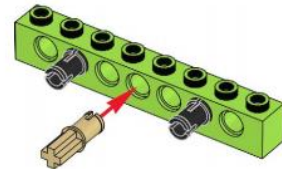

35



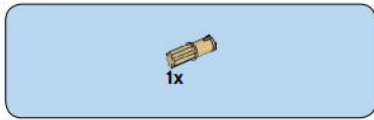

**36**

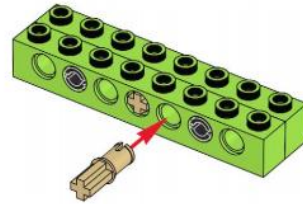

**37**

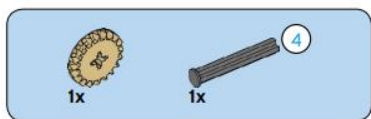
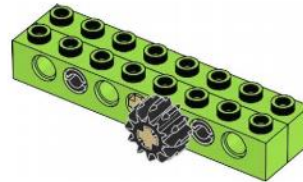

**38**

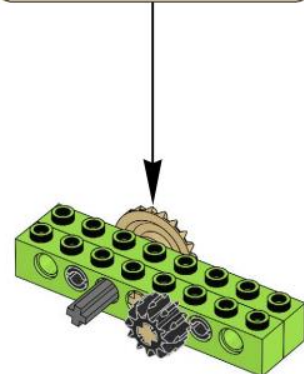
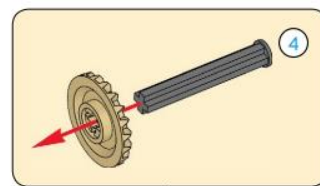



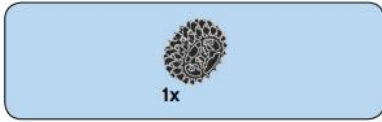

39

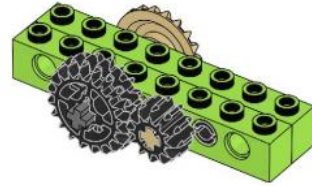

40

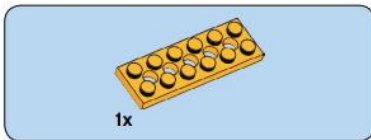

41

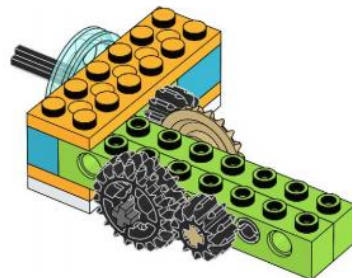

42

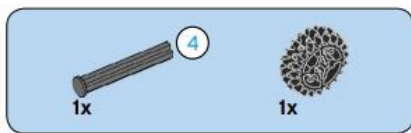
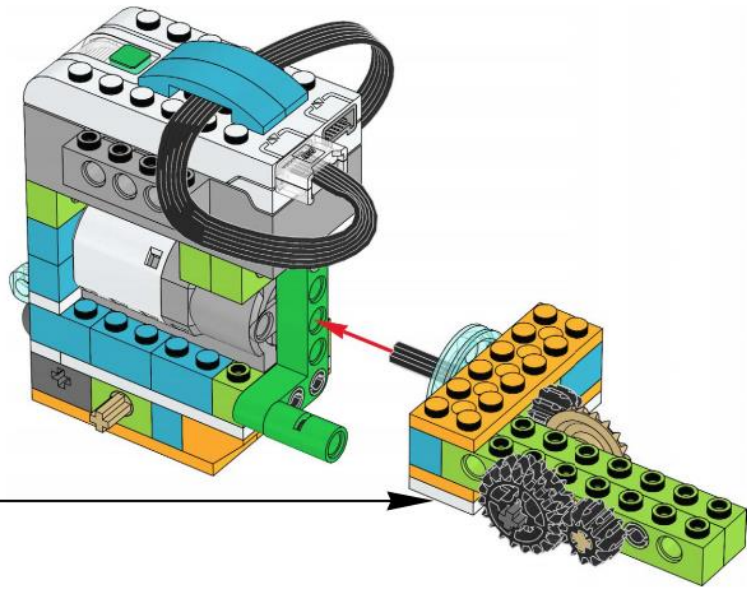

43

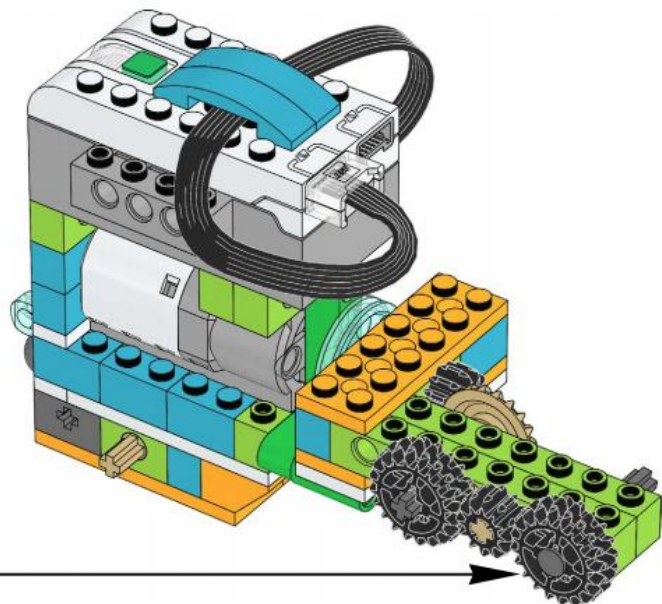
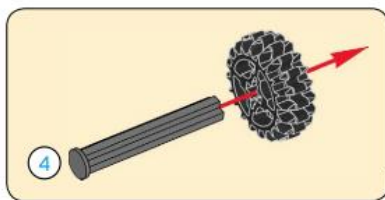

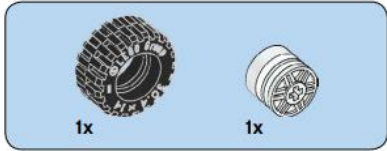

44

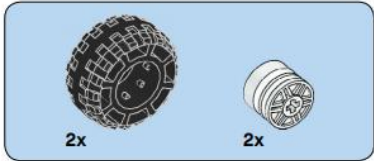
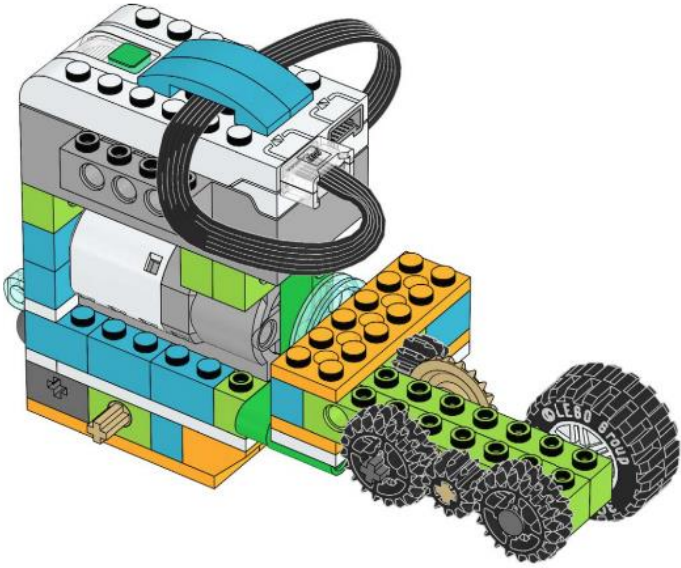

45

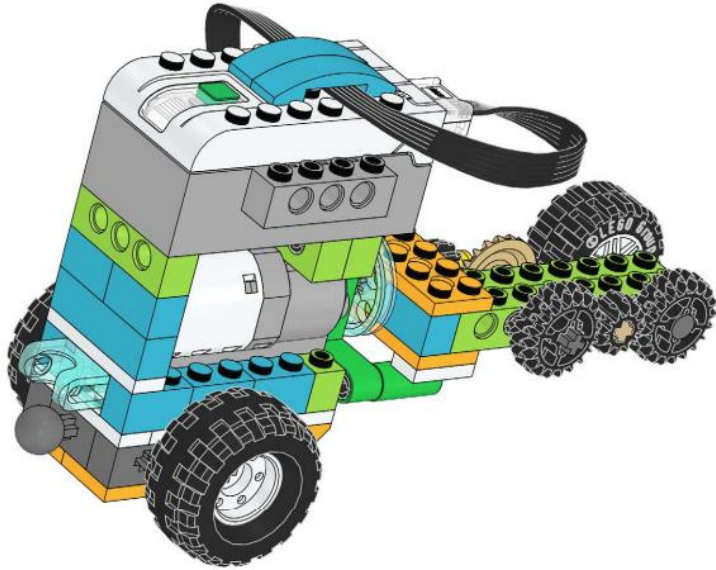

## Codificación

Vamos a dibujar los siguientes botones:

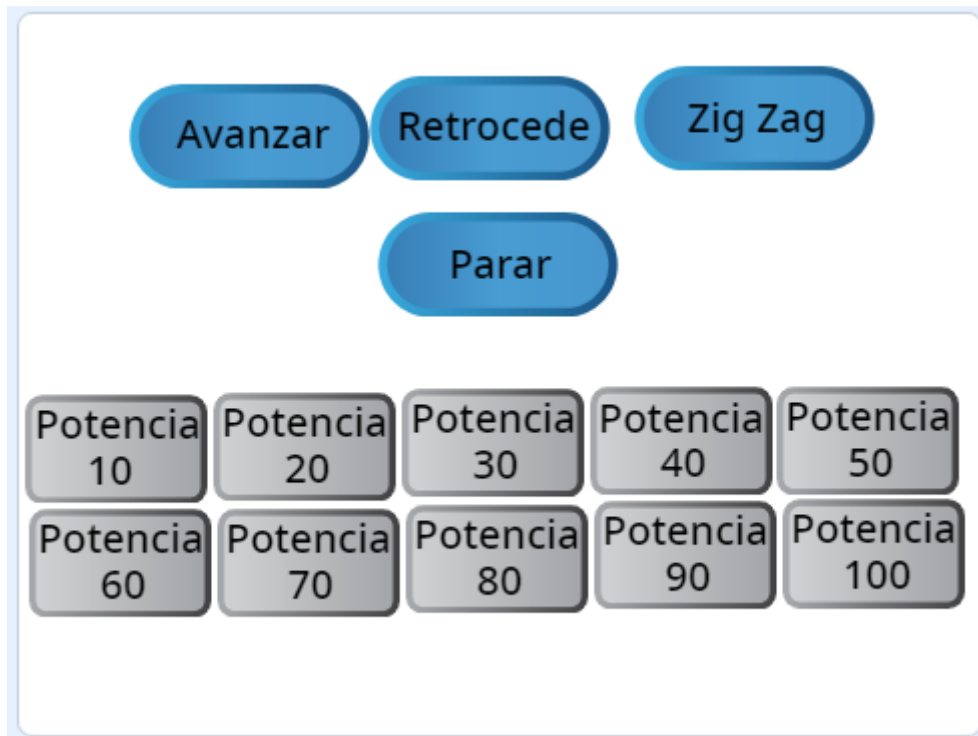

```
al hacer clic en este objeto
dar a avanza el valor 0
fijar dirección de motor a un lado
esperar 1 segundos
dar a avanza el valor 1
```



```
al hacer clic en este objeto
dar a Retrocede el valor 0
fijar dirección de motor a otro lado
esperar 1 segundos
dar a Retrocede el valor 1
```

## Zig Zag

```
al hacer clic en este objeto
repetir hasta que <avanza = 0> o <Retrocede = 0>
  fijar dirección de motor a otro lado
  esperar 0.5 segundos
  fijar dirección de motor a un lado
  esperar 0.5 segundos
```

## Parar

```
al hacer clic en este objeto
  apagar motor
```

Potencia  
10

```
al hacer clic en este objeto
  fijar potencia de motor a 10
```

Potencia  
20

```
al hacer clic en este objeto
  fijar potencia de motor a 20
```

Potencia  
30

```
al hacer clic en este objeto
  fijar potencia de motor a 30
```

Potencia  
40

```
al hacer clic en este objeto
  fijar potencia de motor a 40
```

Potencia  
50

```
al hacer clic en este objeto
  fijar potencia de motor a 50
```

Potencia  
60

```
al hacer clic en este objeto
  fijar potencia de motor a 60
```

Potencia  
70

```
al hacer clic en este objeto
  fijar potencia de motor a 70
```

Potencia  
80

```
al hacer clic en este objeto
  fijar potencia de motor a 80
```

Potencia  
90

```
al hacer clic en este objeto
  fijar potencia de motor a 90
```

Potencia  
100

```
al hacer clic en este objeto
  fijar potencia de motor a 100
```

